



**DUVINAGE**  
Spiral & Circular Stairs

# Baluster Options

Duvinage offers expansive baluster options for any of our stairs. If you do not see what you are looking for in a baluster we can provide additional options or incorporate most any baluster into your custom stair!

<p><b>#700</b></p> <p>● Plain Round</p> <p>Duvinage Quality Standard</p> <p>Available size: • 3/4"</p>	<p><b>#701</b></p> <p>■ Plain Square</p> <p>Available sizes: • 9/16" • 5/8"</p>	<p><b>#702</b></p> <p>■ Plain Square</p> <p>9-3/4"</p> <p>Available sizes: • 9/16" • 5/8"</p>	<p><b>#703</b></p> <p>■ Plain Square</p> <p>24" 6-5/16"</p> <p>Available sizes: • 9/16" • 5/8"</p>
<p><b>#704</b></p> <p>■ Plain Square</p> <p>23-5/8" 5-1/2"</p> <p>Teutonic Collar</p> <p>Available sizes: • 9/16" • 5/8"</p>	<p><b>#705</b></p> <p>■ Plain Square</p> <p>22-3/4"</p> <p>Available sizes: • 9/16" • 5/8"</p>	<p><b>#706</b></p> <p>■ Plain Square</p> <p>24" 5-7/8" 6-1/2"</p> <p>Teutonic Collar</p> <p>Available sizes: • 9/16"</p>	<p><b>#707</b></p> <p>■ Plain Square</p> <p>22-7/16"</p> <p>Available sizes: • 9/16"</p>

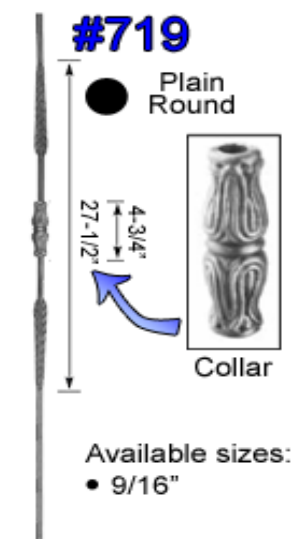
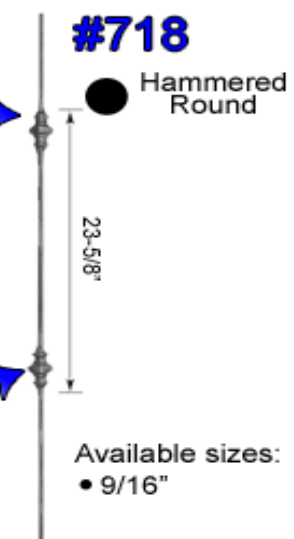
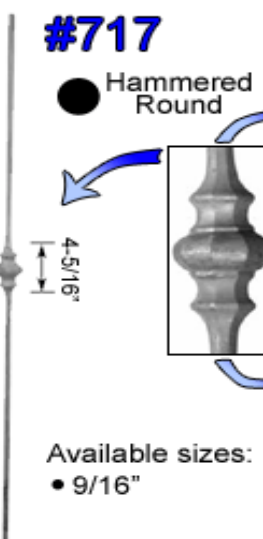
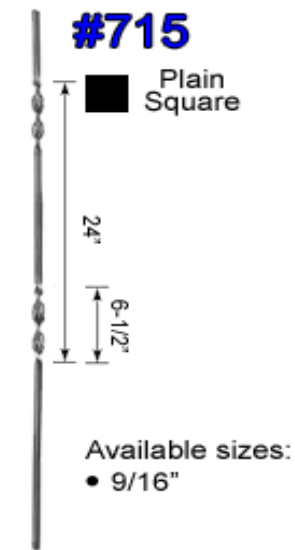
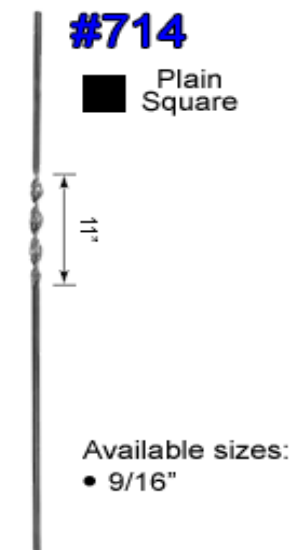
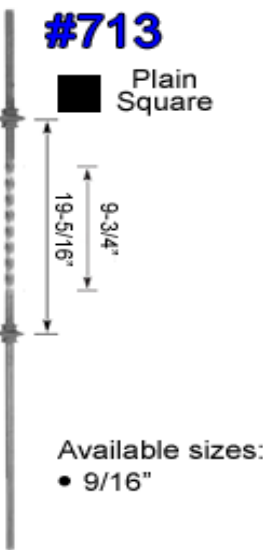
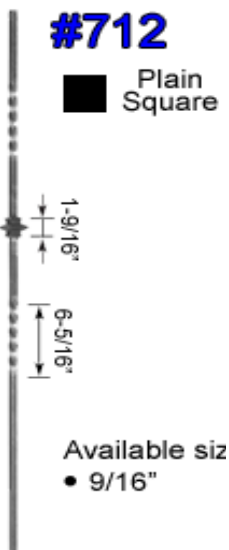
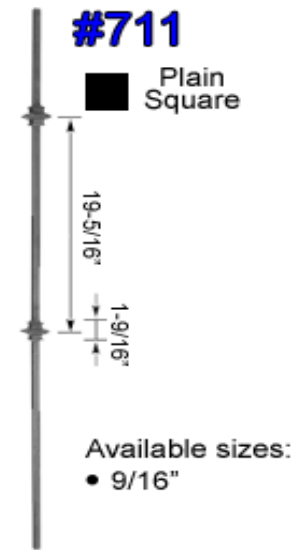
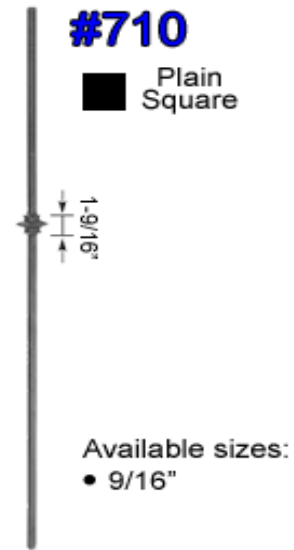
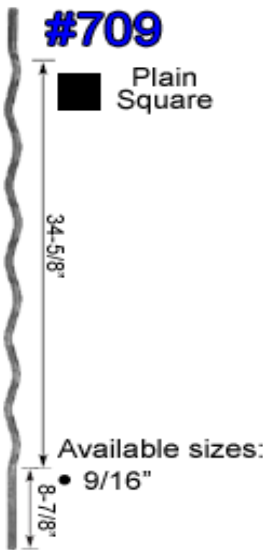
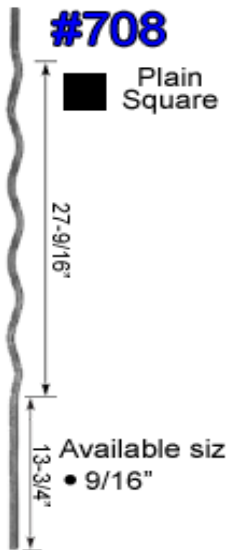

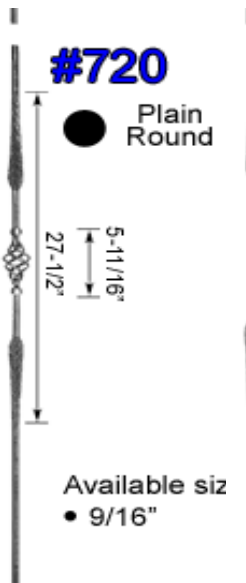
**#720**  
 Plain Round  
  
 Available size:  
 • 9/16"

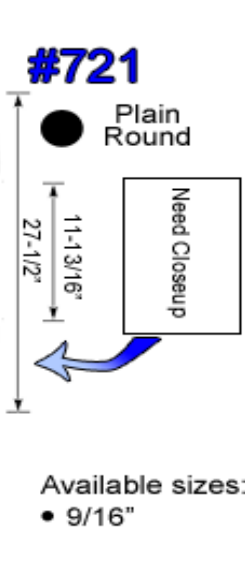
**#721**  
 Plain Round  
  
 Available sizes:  
 • 9/16"

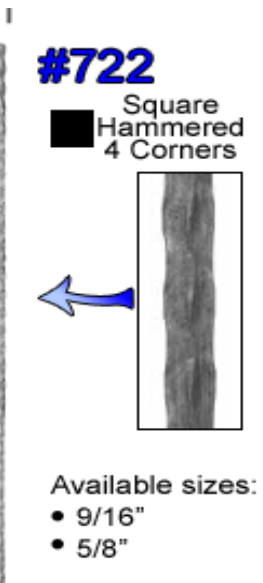
**#722**  
 Square Hammered 4 Corners  
  
 Available sizes:  
 • 9/16"  
 • 5/8"

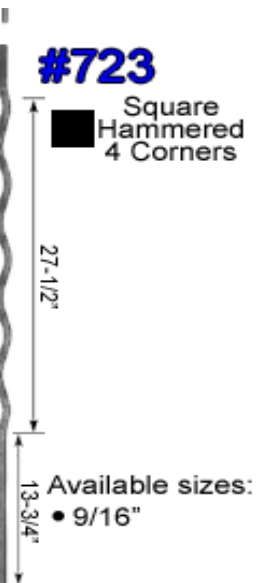
**#723**  
 Square Hammered 4 Corners  
  
 Available sizes:  
 • 9/16"

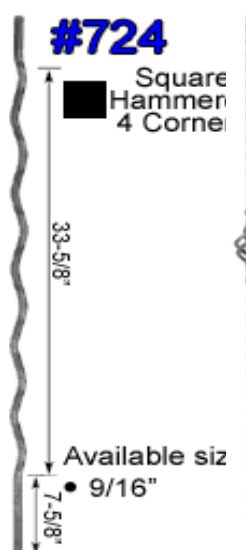
**#724**  
 Square Hammered 4 Corners  
  
 Available size:  
 • 9/16"

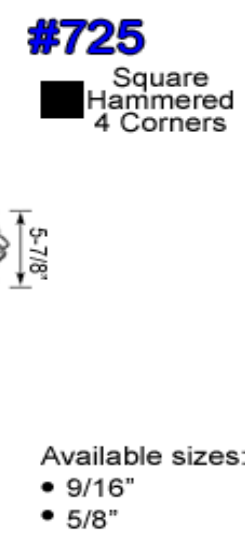
**#725**  
 Square Hammered 4 Corners  
  
 Available sizes:  
 • 9/16"  
 • 5/8"

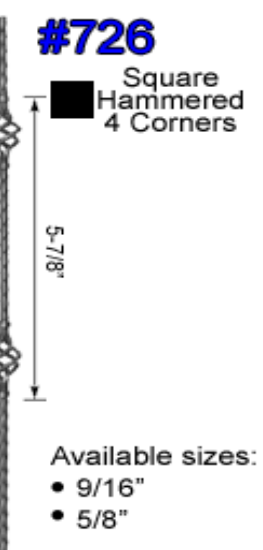
**#726**  
 Square Hammered 4 Corners  
  
 Available sizes:  
 • 9/16"  
 • 5/8"

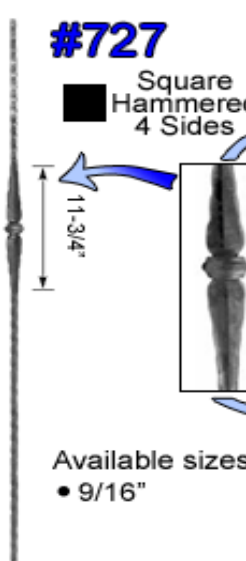
**#727**  
 Square Hammered 4 Sides  
  
 Available sizes:  
 • 9/16"

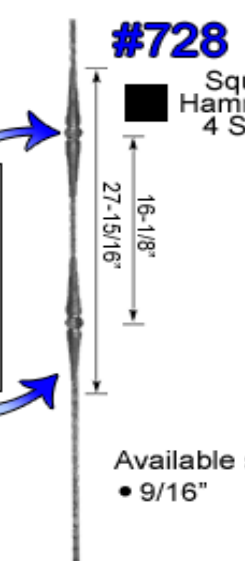
**#728**  
 Square Hammered 4 Sides  
  
 Available size:  
 • 9/16"

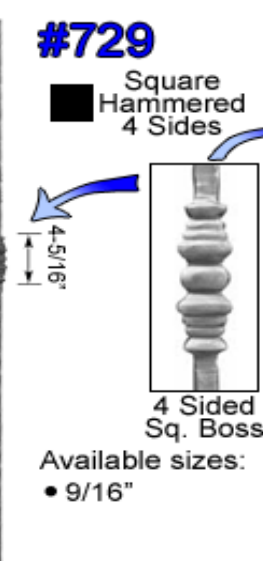
**#729**  
 Square Hammered 4 Sides  
  
 Available sizes:  
 • 9/16"

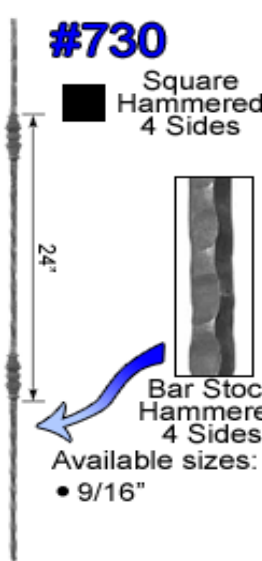
**#730**  
 Square Hammered 4 Sides  
  
 Available sizes:  
 • 9/16"

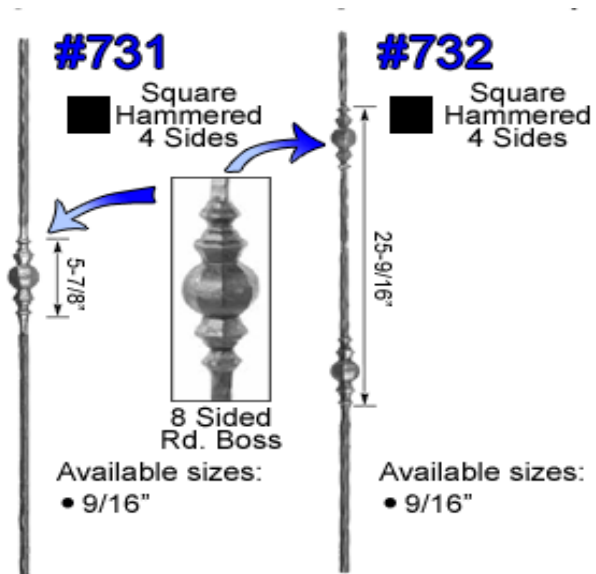

## Standard Baluster Attachments

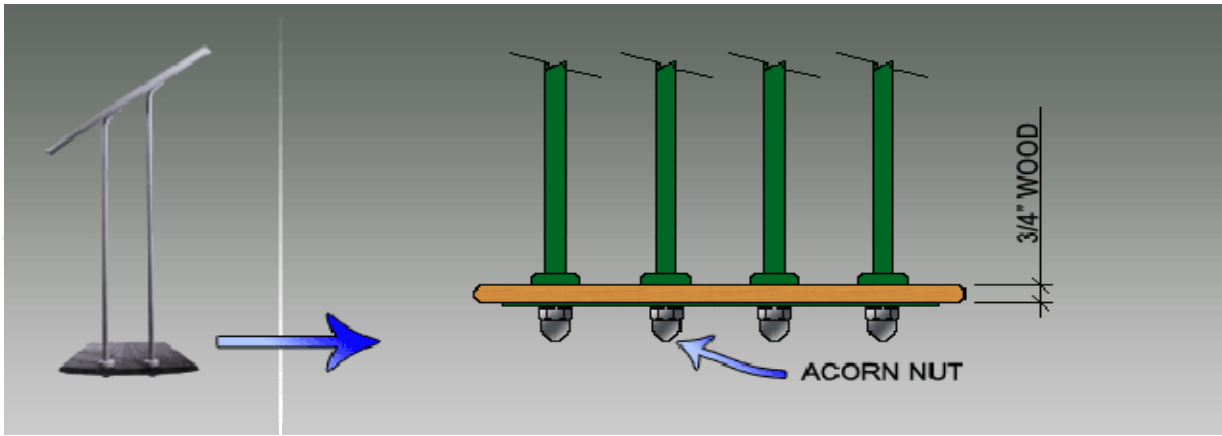

Baluster attachment on a No. 141 Tread Design

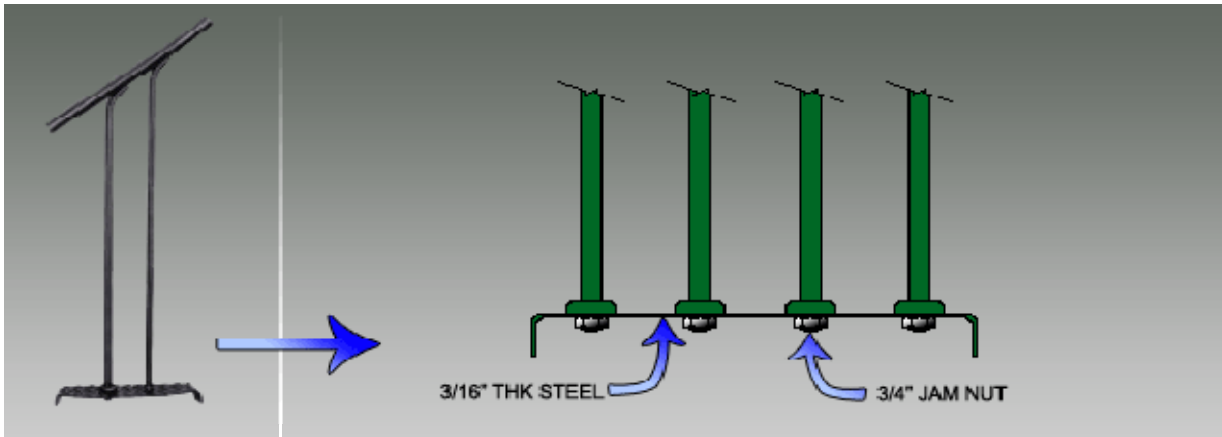

Baluster attachment on a No. 111, No. 131, No. 135, No. 175 Tread Designs

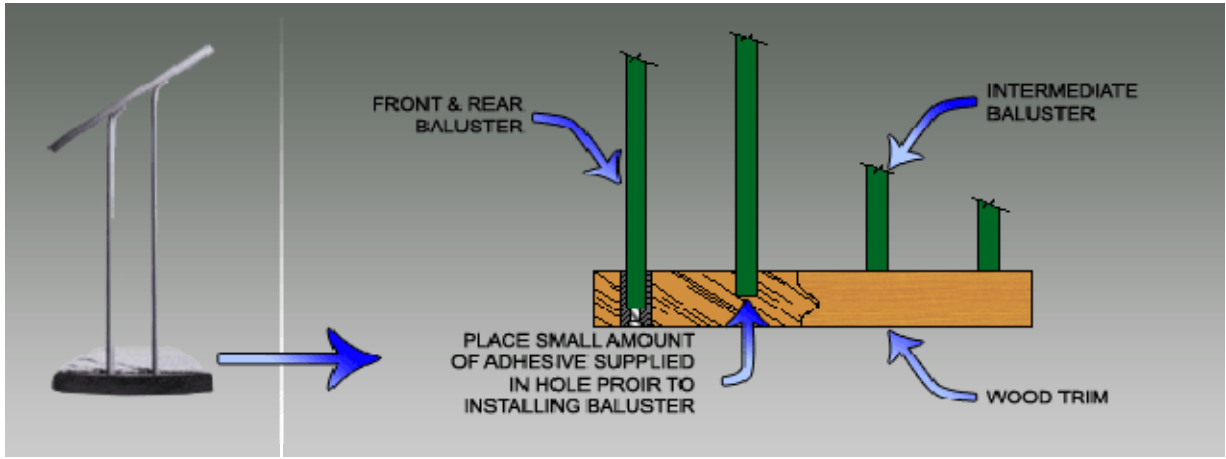

Baluster attachment on a No. 165 Tread Design

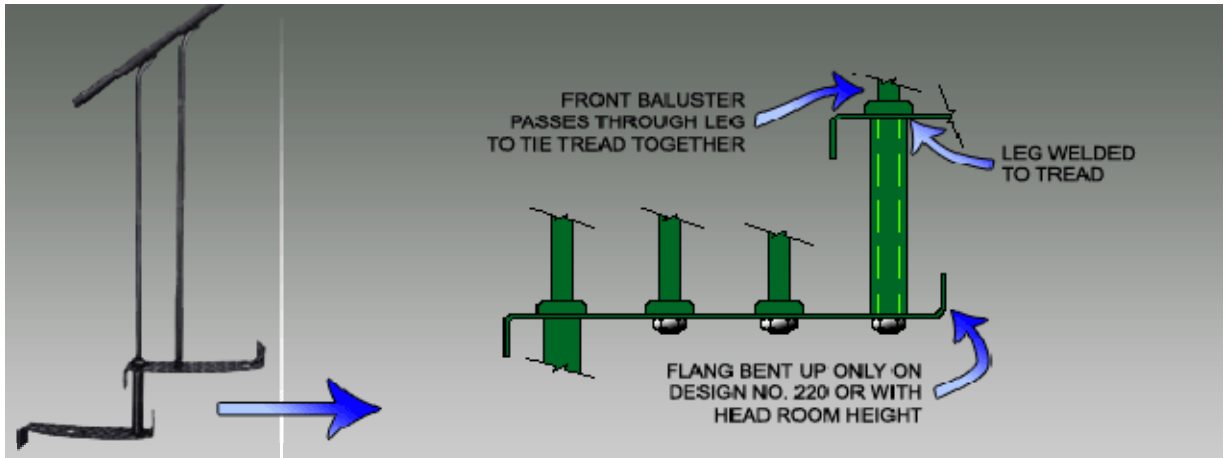

Baluster attachment on a No. 201, No. 220, No. 251, and No. 320 Tread Designs